

Victrix Pro 68 2 ErP

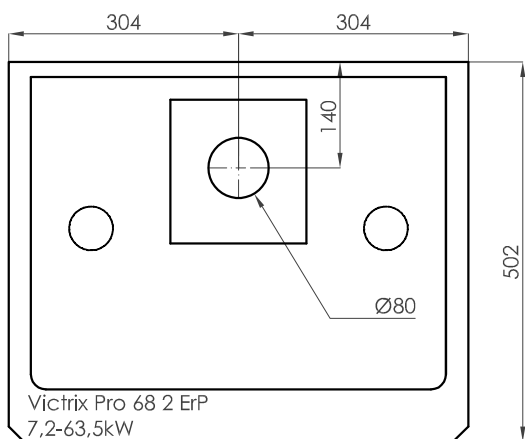
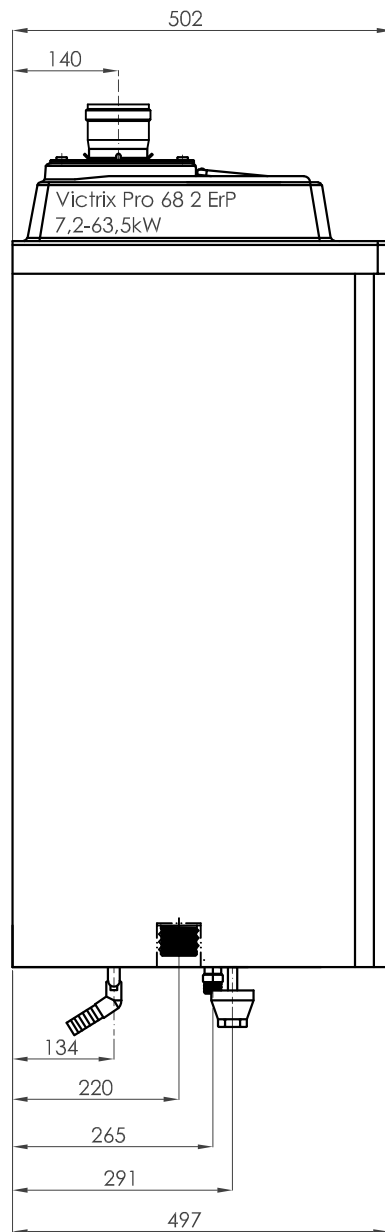
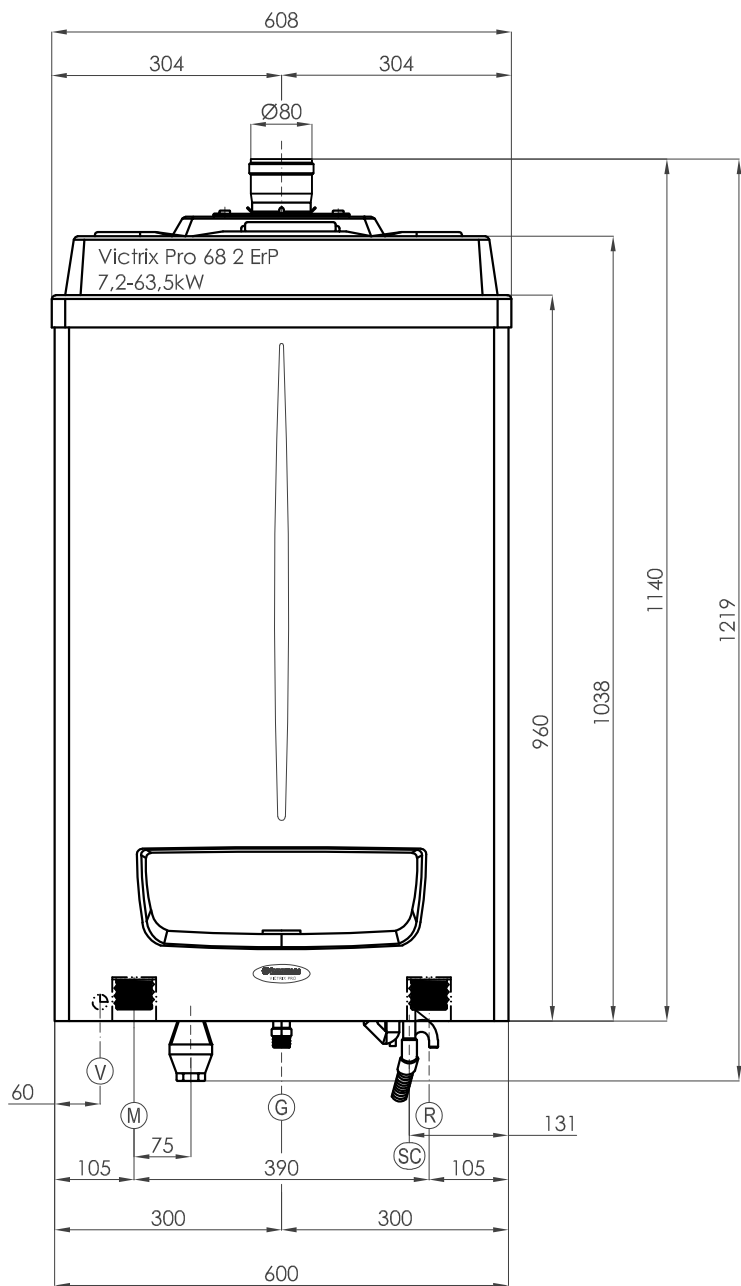

IMMERGAS Polska Sp. z o.o.

Victrix Pro 68 2 ErP

model

kondensacyjny kocioł gazowy, wiszący

rodzaj

moc grzewcza min.
(80/60°C) [kW]

7,2

moc grzewcza maks.
(80/60°C) [kW]

63,5